

# BEFORE YOU GET STARTED...

*We're confident you'll love your gorgeous new Next furniture. However, it's worth making absolutely certain before you put it all together. So, let's quickly run through these three steps:*

## 1. COLOUR

Make sure you're happy with the colour  
No need to unpack everything, just check the first component.

## 2. PROTECTIVE PACKAGING

If you're happy, then it's time to get opening! Start by laying everything out on the protective packaging – this will prevent anything getting scratched.

## 3. PARTS PAGE

Finally, double check you have all the pieces by referencing the parts page of the instructions.

## TIPS FOR RETURNS

Not completely happy with the product? No problem. We just need everything back in the original packaging, so follow the steps below and this will ensure a super-smooth returns process and no delay to your refund.

DO



- Check everything is there (the 'parts page' is a handy checklist).
- Pop all the loose fittings and fixtures into the packaging provided or tie them up in a plastic bag.
- Wrap all the big components back up in the original protective packaging.
- Close up the box and seal it securely (don't be afraid to use plenty of tape).

DON'T



- Leave anything assembled - all components should be dismantled and separately packed.
- Put loose fixtures and fittings straight into the box.
- Throw it back in the box carelessly – as it may get damaged.

next  
HOME

Then just give us a call on 0333 777 8999 and we'll sort out a pick up time for you.

next

# Tulip Dining Table

791770

Assembly instructions

**Actual product size**

H750 x W1000 x D1000mm



**Need HELP?**

With: Assembly instructions  
Missing or damaged parts

**IMPORTANT - RETAIN FOR FUTURE REFERENCE**

**CALL: 0333 777 8999**

## BEFORE YOU START

### Warnings

**Important:** Retain these instructions for future reference.

Unwrap all packaging materials and place the components on top of the carton box or on a clean floor to prevent it from scratching.

This product should only be used on firm, level ground.

Keep small parts out of reach of children.

Please periodically check all fittings and re-tighten as necessary

### Do's

We suggest you spend a short time reading through this leaflet before you start.

We recommend that the packaging is used to protect the surfaces during assembly.

When you are ready to start, make sure that you have the right tools, plenty of space and a clean, dry area for assembly.

Check the pack and make sure you have all the parts listed.

During assembly children should be kept away from the product due to possible risk of injury.

Tools not included.

Due to the size of this product we recommend that it is assembled in the room intended for use.

Ensure that this product is fully assembled as illustrated before use.

Make sure the legs remain in contact with the ground.

Check all screws or bolts are tightened and inspect regularly.

To clean wipe with a sponge and warm soapy water. Do not use solvent based cleaners or detergents as they can bleach or damage the product.

When cleaning glass panels use a damp cloth with washing up liquid or soft soap if necessary. Do not use washing powders or any other substances containing abrasives since these substances scratch glass panel

The glass used in this product is toughened and complies with BS EN 12150-1:2009

### Dont's

Do not use power tools to construct this product.

Do not tighten screws until fully assembled.

Do not overtighten screws or bolts.

Do not sit or stand on the product.

Do not use this product if parts are missing, damaged or worn.

Never use scourers, abrasives or chemical cleaners.

If the glass is chipped or broken, stop using the product and consult Next

Do not place very hot or very cold items on the glass surface, unless adequately thick table mats are used to prevent such items from coming into contact with the glass

Do not use glass as a chopping surface. Do not strike the glass with hard or pointed items

### Number of people required to assemble

One person to assemble the unit and one person to lift the unit into position.

### Time to assemble

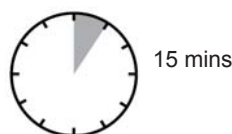

### Tips

Look out for the symbol throughout this manual. Wherever you see it we will have a handy tip to help you with the assembly of your product.

### Tools required

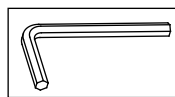

### Missing parts

If you are missing any fixtures and fittings for your product please contact our customer service team on 0333 777 8999 and they will be happy to arrange for a replacement to be sent to you free of charge.

### Home service technicians

If you have a fault with your product please contact our customer service team on 0333 777 8999. If you have had the product for 28 days or less you may be offered a replacement, refund or for a fully trained home service technician to visit your home to assess the fault and repair the product where possible. If you have had the product for more than 28 days we will send an independent home service technician to review and repair the product where possible and recommend further action.

### You can write to us at

Next Retail Ltd,  
Desford Road,  
Leicester,  
LE19 4AT

To view our full furniture range please visit [www.next.co.uk](http://www.next.co.uk)

## GETTING TO KNOW YOUR PRODUCT

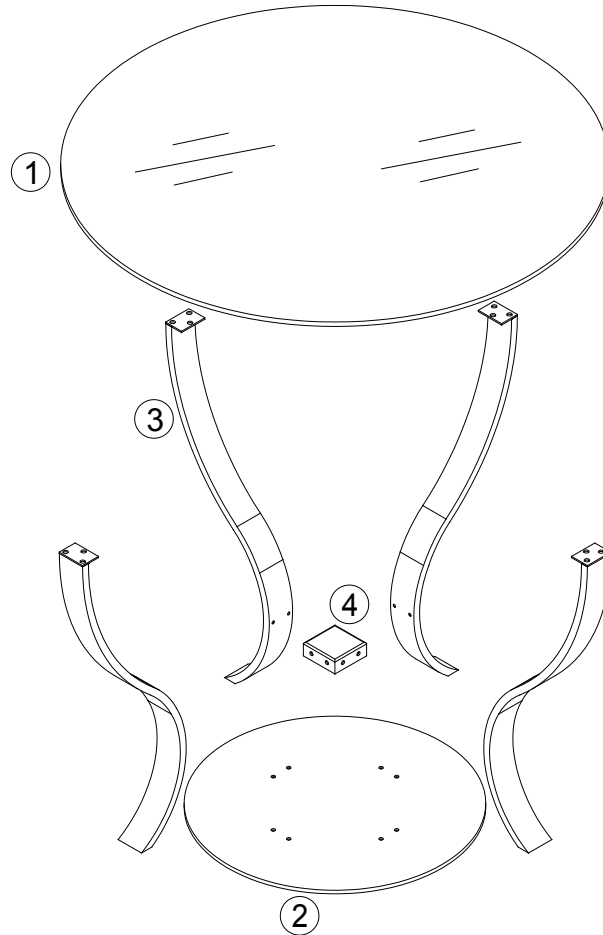

Components supplied. Please use this guide if you require replacement parts.

| Ref | Dimensions  | Visual | Qty | Ctn |
|-----|-------------|--------|-----|-----|
| 1   | ∅ 1000x20mm |        | 1   | 1   |
| 2   | ∅ 550x10mm  |        | 1   | 2   |

| Ref | Dimensions   | Visual | Qty | Ctn |
|-----|--------------|--------|-----|-----|
| 3   | 718x267x60mm |        | 4   | 2   |
| 4   | 81x81x30mm   |        | 1   | 2   |

Fixtures and fittings  
supplied (actual size)

| Ref | Dimensions | Qty | Spare Qty |
|-----|------------|-----|-----------|
| A   | M8 x 8mm   | 4   | 1         |
| B   | M6 x 12mm  | 8   | 1         |
| C   | M8 x 15mm  | 8   | 1         |
| D   | 4mm        | 1   | N/A       |

mm 10 20 30 40 50 60 70 80 90 100

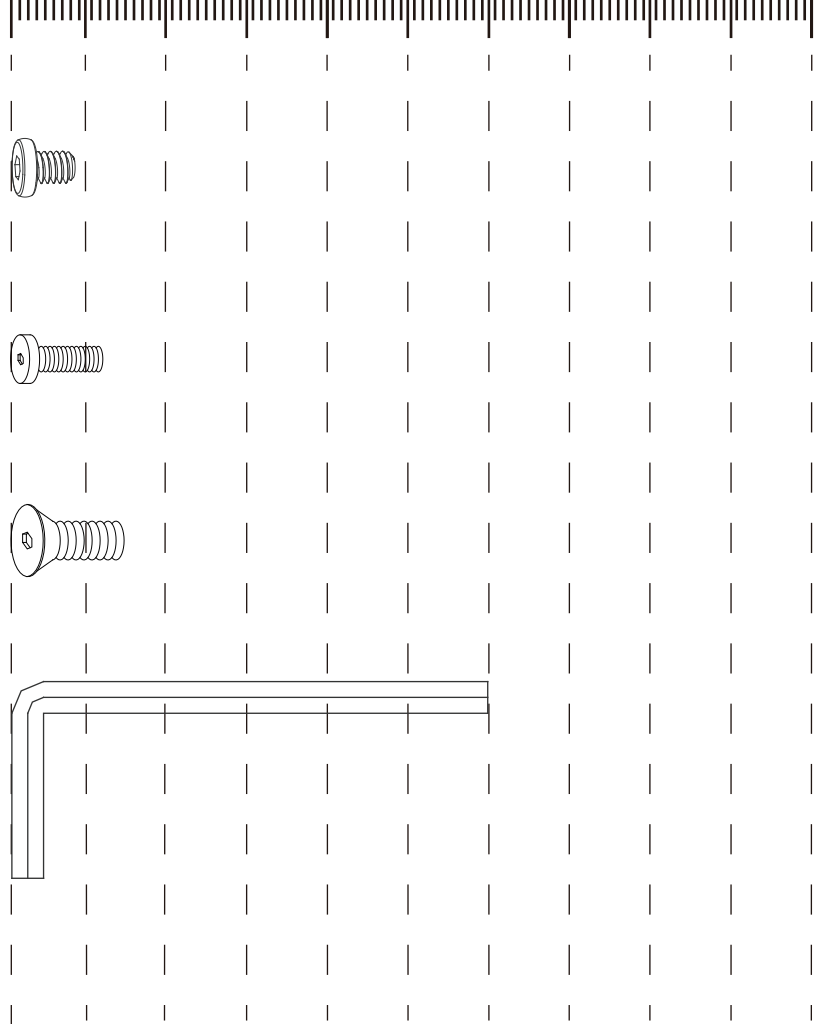

1

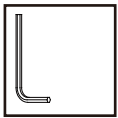
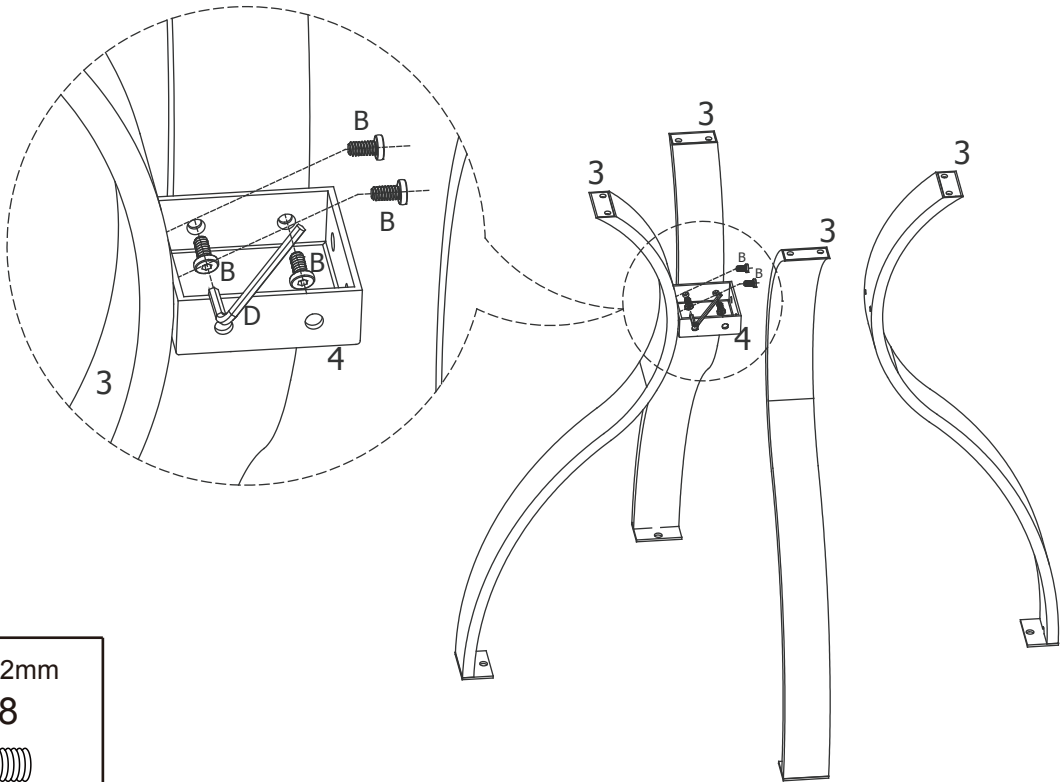

M6 x 12mm

B x 8



2

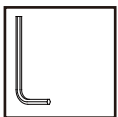
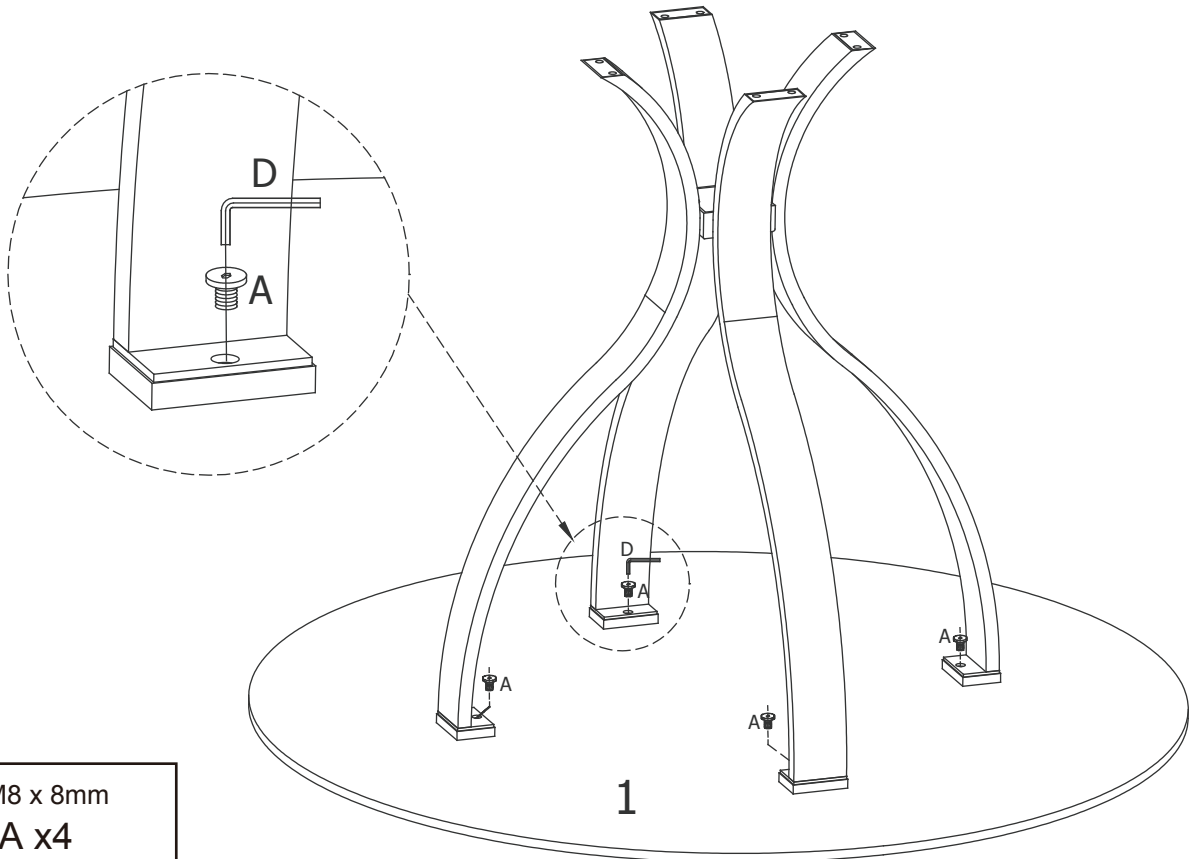

M8 x 8mm

A x 4



3

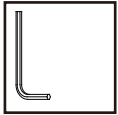
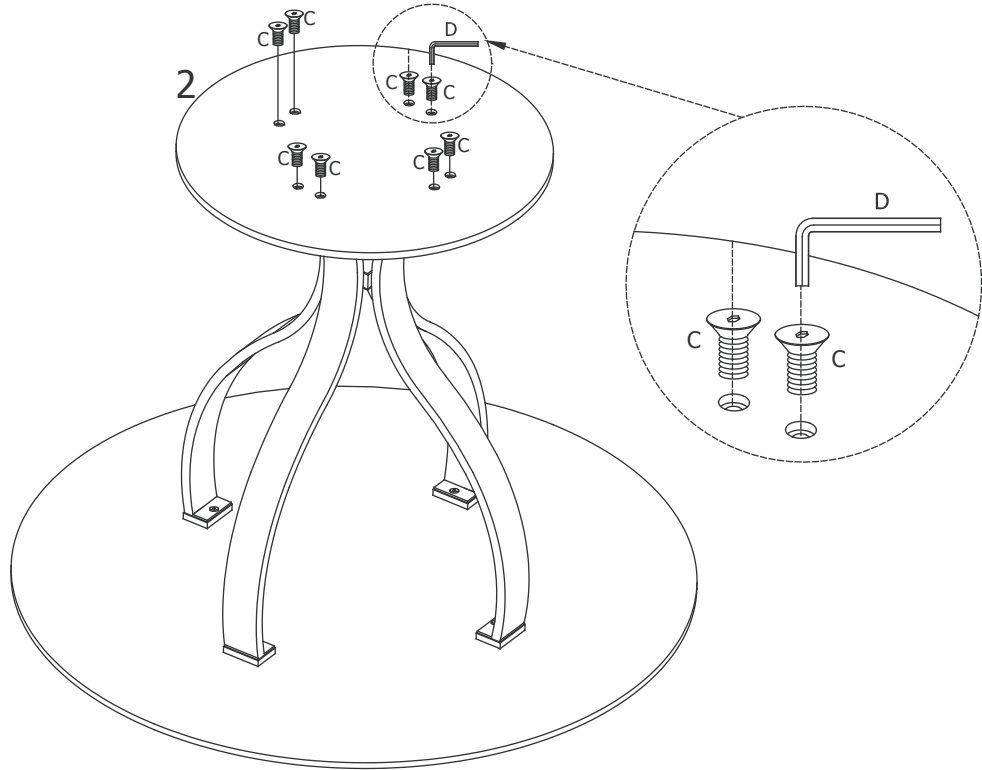

M8 x 15mm

C x8



4

